

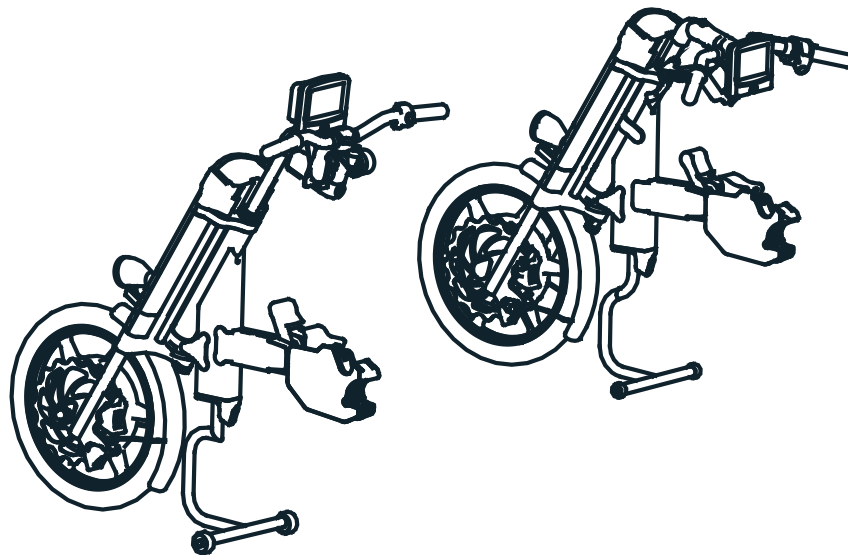

Infinity User manual



The undersigned, representing the following manufacturer

Decon Wheel AB
Org.No. 556618-9006
Södra Ekeryd 119, 314 91 Hyltebruk
Sweden

hereby declares that the product

Infinity

with the basic UDI-DI 735001014INFBE

and the following references

INF001
INF003
INF004
INF005

is in conformity with the Medical Device Regulation (MDR) 2017/745 as a class I medical device based on Annex VIII.

Intended purpose: The device is an electric drive unit for manual wheelchairs with the intention to provide mobility and flexibility to persons who are unable to walk or have restrictions on walking. The device is intended for outdoor use.

This EU declaration of conformity is issued according to Annex IV in MDR and under sole responsibility of the manufacturer.

Hyltebruk, 2022-05-30

A handwritten signature in blue ink, appearing to read 'Benny Andersson'.

Benny Andersson
COO

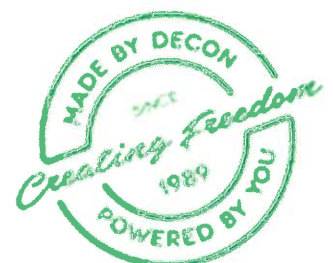

Contents

Safety	4
General regulations.....	4
Manuals for the visually impaired	4
Purpose and intended use.....	4
Not intended use	4
Markings.....	5
Symbols.....	6
Warnings.....	6
Guarantee	11
Product safety and recall information	11
Product description	12
Technical data	12
Scope of delivery	13
Overview Infinity.....	14
Overview Infinity Tetra	15
Wheelchair coupling system	16
Drive system.....	16
Manoeuvre system Infinity.....	16
Manoeuvre system Infinity Tetra	16
Braking system Infinity	16
Braking system Infinity Tetra.....	17
Lighting.....	17
Display	18
Menu structure.....	18
PIN code (Optional).....	19
Home menu.....	20
Driving profile (A)	21
Energy flow indicator (B)	21
Speedometer (C)	21
Settings (D)	22
Personal driving profile.....	22
Device settings.....	23
Info about the device.....	24
Mechanical settings Infinity	26
Mechanical settings Infinity Tetra	27
Using Infinity and Infinity Tetra	28
Connecting Infinity to your wheelchair	28
Connecting Infinity Tetra to your wheelchair.....	30
To remove and install the adapter bar.....	32
Running Infinity	33
Parking brake Infinity.....	33
Running Infinity Tetra	34
Parking brake Infinity Tetra.....	34
Techniques for passing obstacles and driving uphill.....	35
Moving Infinity connected to a wheelchair	35
Transport of Infinity	36
Battery and charger.....	38
Care	40
Cleaning	40
Corrosion	40
Maintenance	41
Repairs	42
Reuse.....	42
Waste disposal	42
Troubleshooting	43
Error descriptions	43
Error codes.....	44

Safety

General regulations

The user manual applies to Infinity.

The user manual is written for users of Infinity and anyone who can help the user to get the best use of Infinity.

Read the user manual and familiarise yourself with Infinity before using it.

Manuals for the visually impaired

Contact your local dealer if you have difficulty reading this user manual. Your local dealer can supply a digital copy of this manual. This allows you to enlarge the manual or read aloud from your reading software.

Purpose and intended use

Infinity is an electric drive unit intended to provide power assistance and increased mobility to people aged twelve and upwards, who have a disability, when using a manual wheelchair. The person's weight must not exceed what is stated in the technical specification in this manual.

The prerequisites for being able to use the product are that the person in question has at least one arm with sufficient strength to be able to operate the controls on the product. Furthermore, sufficient cognition and motor skills are necessary for the person to be able to operate the product in a safe manner. The assessment of the person's ability is carried out by Decon or a representative appointed by Decon, such as assistive technology centres and retailers.

The product can be used both indoors and outdoors with an emphasis on the outdoors. Use in outdoor environments is mainly on paved surfaces such as roads and cycle paths as well as gravel tracks. Use in indoor environments is mainly larger public premises such as libraries, grocery stores, shopping centres, hospitals and other similar environments.

For information on which wheelchair models Infinity can be mounted on, see Decons website, www.decon.se/en

Not intended use

Any use that does not correspond to the description in this user manual. This also includes the technical specification, i.e. maximum user weight, maximum gradeability, etc.

Markings

The model plate is located on the steering column.

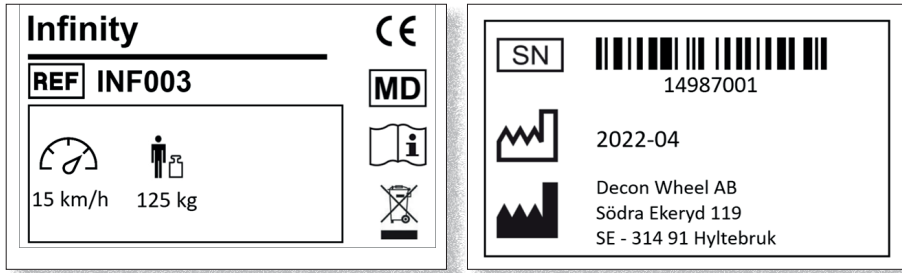

The symbols used on the label of Infinity are explained below



Observe the instructions for use!



Maximum weight of person: 125kg



Maximum speed of the device: 15km/h



Medical device produkt



Serial number of the device



Indication of the date of manufacture



Name and adress of the manufacturer



Catalogue number of the device



Recycled as electronic waste. Infinity and its accessories are subjected to the European WEEE Directive.

Symbols



WARNING!

Risk of serious injury or death.

An operation which, if not performed correctly, could result in injury to the operator or other persons.



CAUTION!

Risk of damage to property.

An operation that, if not performed correctly, may lead to damage to property.



INFO

Highly important or explanatory information.

Warnings

Before using Infinity for the first time



WARNING!

The user must have read and understood the manual and have an understanding of the various controls and user interfaces that Infinity is equipped with.



WARNING!

Before using Infinity, assess your skills and decide if you need an assistant.

To determine the need for an assistant, also request an expert opinion for reference.

If your assessment is based solely on your own opinion, you or people around you may be harmed.



WARNING!

Practice driving on level ground in a safe environment with an assistant, until you feel confident about how Infinity works.

If you drive on public streets when you are not sure how to use Infinity, you or other people around you may be injured.



WARNING!

Do not place your fingers or hands under the locking handle when this is lowered. If you do, your finger(s) or whole hand may become trapped.



WARNING!

Do not place your fingers or hands on the rotation lock when turning the handlebars.

If you do, your finger(s) or whole hand may become trapped between the rotation lock and the tubes.

**WARNING!**

Be careful not to get your finger trapped when inserting or removing the battery.

**WARNING!**

Be careful when attaching Infinity to the wheelchair and lifting the castors off the ground. Feet can get trapped between the arch / footrest on the wheelchair and Infinity. Feet and toes may then be injured.

**WARNING!**

It is extremely important that all screws are tightened correctly after installation.

Driving**WARNING!**

Do not make sharp turns at high speed. There is a risk that Infinity and the wheelchair will overturn.

**WARNING!**

When driving on a steep descent, the speed and braking distance may exceed that specified in EN12184: 2014 Table 1 and Table 2 as well as that in the technical specification.

**WARNING!**

When driving on a steep descent, it may be necessary to apply the brakes to limit the speed. Engine braking is only effective to a certain extent.

**WARNING!**

Do not drive Infinity with heavy bags or other packing hanging on the wheelchair backrest. Also, do not place heavy objects in the storage compartment. When going uphill, the wheelchair can easily tip backwards, which can cause you or those around you to be injured.

**WARNING!**

Never drive Infinity when not seated in the wheelchair.

**WARNING!**

Never drive Infinity with more than one person in the wheelchair. Infinity may stop working or those sitting in the wheelchair may be injured.

**WARNING!**

Check the remaining battery capacity before crossing a street or road. If the remaining battery capacity is low, Infinity may stop.



WARNING!

Be careful when using Infinity so that you do not get your hands caught in the wheelchair or Infinity's spokes, brake disc etc.



INFO

Use the parking brake when you have stopped at, for example, a traffic light or a pedestrian crossing.



INFO

Infinity is equipped with a regenerating engine brake that is activated when the throttle is released. For maximum range, plan the drive so that it is used as much as possible, e.g. reduce acceleration well before an intersection.

Road conditions



WARNING!

Do not drive with Infinity outdoors in heavy rain or snow. Drivers of other vehicles may have difficulty seeing you. If it starts to rain or snow when you are outdoors, make your way indoors as quickly as possible.



WARNING!

Do not drive Infinity on icy surfaces. There is a risk that you won't be able to stop Infinity.



WARNING!

Do not drive in areas with deep snow or standing water. There is a risk that you will lose control. If you can not get around the area make sure you have an assistant with you. If you drive Infinity in deep water and water penetrates the drive unit, this may cause Infinity to stop.

Trains and busses



WARNING!

When traveling by train, always have an assistant with you. Stop on the platform so that you are facing the tracks and apply the parking brake on the Infinity as well as the wheelchair brakes. Some platforms are slightly inclined towards the tracks.



WARNING!

When you are boarding or disembarking a bus or train, always have an assistant with you.

Driving on slopes

**WARNING!**

The centre of gravity of Infinity coupled with a wheelchair will be different than you are used to. Therefore, you must be extra careful when driving on slopes. Do not use Infinity on slopes with a slope greater than 8 degrees (14%). Infinity and the wheelchair may tip over, not move forwards or the braking ability may be inadequate. The first time you drive up or down a hill, you should have an assistant with you.

Railway crossings

**WARNING!**

If possible, avoid railway crossings.
If you have no choice but to cross the railway, be sure to have an assistant with you. Always stop before the level crossing and look to both the right and left. When crossing the railway, make sure to approach as close to perpendicular to the railway tracks as possible. If you drive diagonally, the wheels of Infinity or the wheelchair may get stuck in the railway tracks. Do not drive near the edge of the level crossing. The wheels may end up outside the level crossing.

**WARNING!**

Check the remaining battery capacity before crossing a railway. If the remaining battery capacity is low, Infinity may stop.

Storage and transport

**WARNING!**

Do not store Infinity where it may get wet from rain or in places with high humidity.

**WARNING!**

Avoid storage in direct sunlight or high temperatures.

**WARNING!**

Infinity must never be transported when coupled with the wheelchair. In vehicles where the wheelchair is used as a seat, Infinity must be disconnected from the seat and placed in the luggage compartment or equivalent and load secured.

**WARNING!**

Use straps to ensure that Infinity can be transported safely.

**WARNING!**

Be careful not to get your finger trapped when inserting or removing the battery.

**WARNING!**

Always store the disconnected battery with the protective cover on. Exposed contacts can cause a short circuit, fire or battery rupture.

! **CAUTION!**

Position Infinity so that no parts are damaged during transport.

Cleaning

! **CAUTION!**

Never wash Infinity with a hosepipe or high pressure washer. Do not use steam a cleaner to clean Infinity. The electronic devices may be damaged, which can lead to serious malfunctions.

! **CAUTION!**

Do not clean with solvents such as petrol or thinner. This may damage paint and plastic parts on Infinity



INFO

A cloth and alcohol-based sanitiser is suitable to disinfect Infinity.

General use



WARNING!

Do not touch the Power module at the bottom of the front, drive wheel, brake disc or caliper when Infinity is in use or after use. During and after use, they can be very hot. If Infinity is near a heat source, the drive motor may become very hot.

Never leave or store Infinity so that it is exposed to direct sunlight. Any metal surfaces on the product may become very hot. Too high a temperature can also cause the battery to malfunction or accelerate the decomposition of the battery.



WARNING!

It is extremely important that all screws are tightened correctly after installation.



WARNING!

Make sure that the adapter bar is properly fixed to the adapter plates.



WARNING!

Do not use Infinity near devices that generate strong radio waves. If Infinity is near a radio wave source and starts to function abnormally, turn off the power immediately, and move quickly from the current location, with the help of your assistant or by rolling Infinity connected to the wheelchair from there manually.

The weak electromagnetic waves emitted by Infinity may affect other electronic devices, such as automatic doors and anti-theft systems of the type used in stores. In this case, turn off the power and operate Infinity connected to the wheelchair with the help of an assistant or manually.

Guarantee

The warranty period for Infinity is 2 (two) years from the date of purchase

If there is a material or manufacturing defect on your Infinity during this warranty period, the defective parts will be replaced or repaired free of charge. The warranty covers the drive and the charger. Consumables such as batteries, tyres and hose are excluded from this warranty.

This warranty does not cover faults caused either by intentional misuse by the user or careless use, such as faults caused by use other than that specified in this manual. This warranty also does not cover faults that have occurred as a result of modification of the unit or continuous use under conditions other than the specified conditions, for example maximum weight exceeded etc.

Scratches, matting and dirt on the surface of the product as a result of normal use are not covered by the warranty.

If warranty repairs are necessary, contact the dealer where you purchased the unit.

The expected service life of the complete product is (not including consumables) 5 years from the date of sale.

Product safety and recall information

Contact the retailer where the device was purchased or the manufacturer of Infinity for product safety information and any recalls.

Product description

Technical data

Engine	Brushless PM motor 500W
Battery type	Li-Ion 48V, 10Ah (480 Wh)
Total dimensions excl. wheelchair (WxLxH)	580x900x820mm ^{4) 5)}
Total weight Infinity incl. battery	24kg
Wheel dimension	16 "
Tyre dimension	16x2,125 "
Air pressure in tyres	2 bar
Speed	0-15 km / h ¹⁾
Maximum mileage from fully charged batteries	45km ²⁾
Max user weight	125 kg
Maximum gradient	8 degrees ³⁾
CE marking	According to EU Regulation 2017/745 (MDR)
Battery charger	100-240 V AC, 50 / 60Hz
Charging time	Normal charging about 3-4 hours
Operating conditions	environment temperature humidity
	Indoor and outdoor -15 ° C to 40 ° C No condensation
Wheelchair classification (SS-EN 12184:2014)	Class B
Minimum corridor width that Infinity can be used in	Varies depending on which wheelchair Infinity is connected to
Maximum height of obstacles that can be passed.	50 mm
Static stability (ISO 7176-15, Annex A)	Class B in all positions (front, rear, side), i.e. at least 9 degrees incline or higher.
Dynamic stability uphill (ISO 7176-15, Annex A)	Class B, incline at least 6 degrees
Obstacle climbing (ISO 7176-15, Annex A)	Class B, 50 mm
Maximum forward speed (ISO 7176-15, Annex A)	5-15 km / h
Braking distance from maximum speed (ISO 7176-15, Annex A)	0.8-4.5 m
Minimum turning radius (ISO 7176-15, Annex A)	Varies depending on which wheelchair Infinity is connected to. Approx 2.4 m with a chair with a seat width of 42 cm.

1. Can be adapted to comply with current laws and regulations

2. Driving style, surface and user weight affect the maximum mileage

3. Maximum gradeability depends on the chair's balancing and surface.

4. Recommended measurements for Class B wheelchairs according to EN12184:2014 A1.1 is exceeded when Infinity connects to a wheelchair.

5. Recommended measurements for wheelchairs according to PRM-TSI Annex M is exceeded when Infinity connects to a wheelchair.

Scope of delivery

The delivery of Infinity includes the following:

- A Infinity
- B Charger incl. cabling
- C User manual
- D Adapter for charging

Adapter kit



INFO

Adapter kit ordered separately.

An adapter kit is required to connect the Infinity to a wheelchair. The adapter kit must be installed by a trained technician.

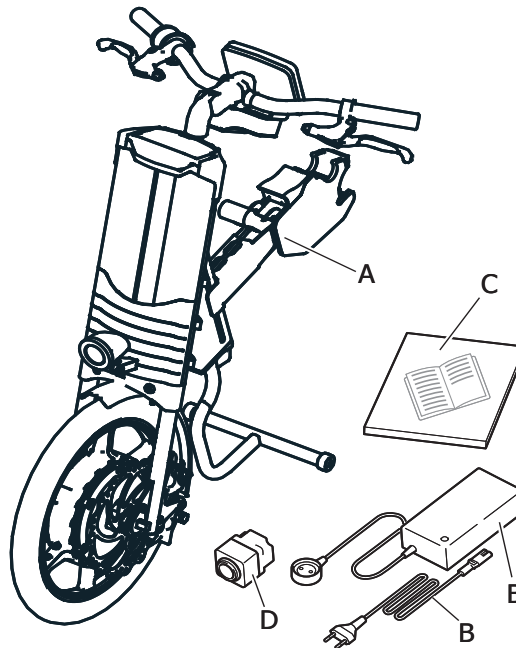

Overview Infinity

Infinity mainly consists of two parts. A front part for manoeuvring and driving and an intermediate part for connecting to the wheelchair.

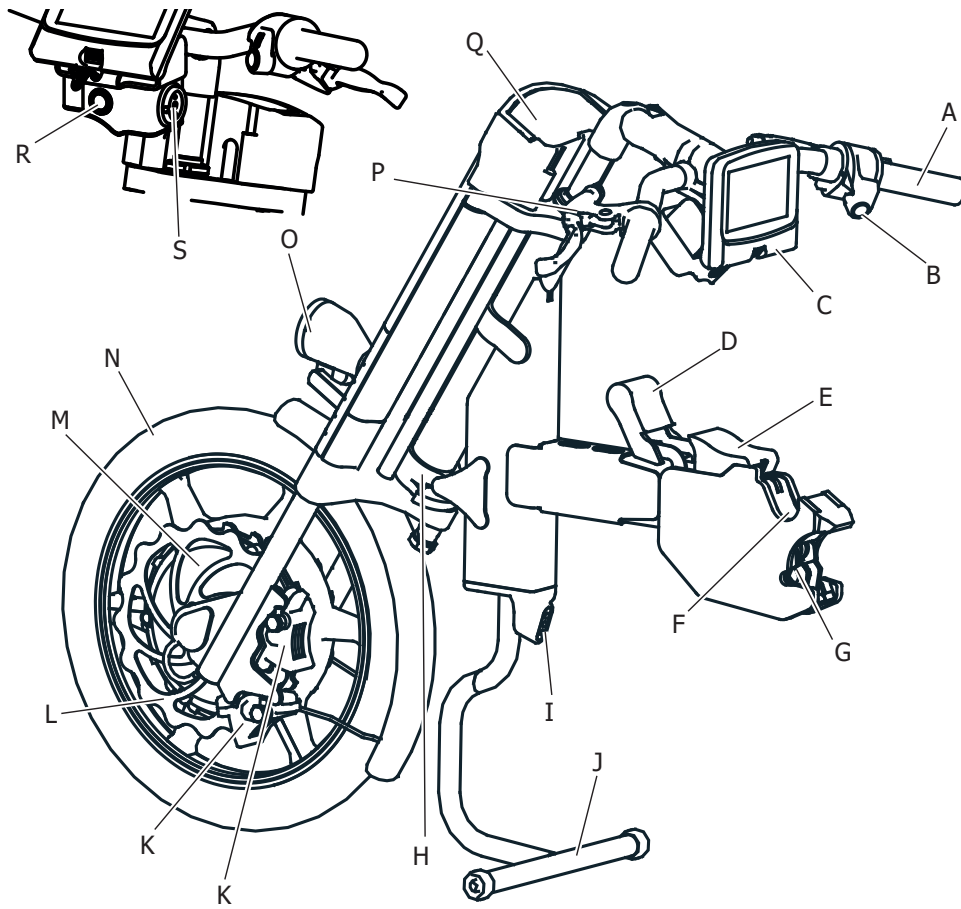

- | | | | |
|---|-------------------------|---|-----------------------------|
| A | Throttle control | J | Support legs |
| B | Reverse button | K | Brake caliper (x2) |
| C | Display | L | Brake disc |
| D | Locking handle | M | Drive motor |
| E | Release handle | N | Drive wheels |
| F | Upper docking mechanism | O | Front lighting |
| G | Lower docking mechanism | P | Brake lever (x2) |
| H | Rotary lock | Q | Battery holder with battery |
| I | Rear lighting | R | Start button |
| | | S | Charging socket |

Overview Infinity Tetra

Infinity Tetra mainly consists of two parts. A front part for manoeuvring and driving and an intermediate part for connecting to the wheelchair.

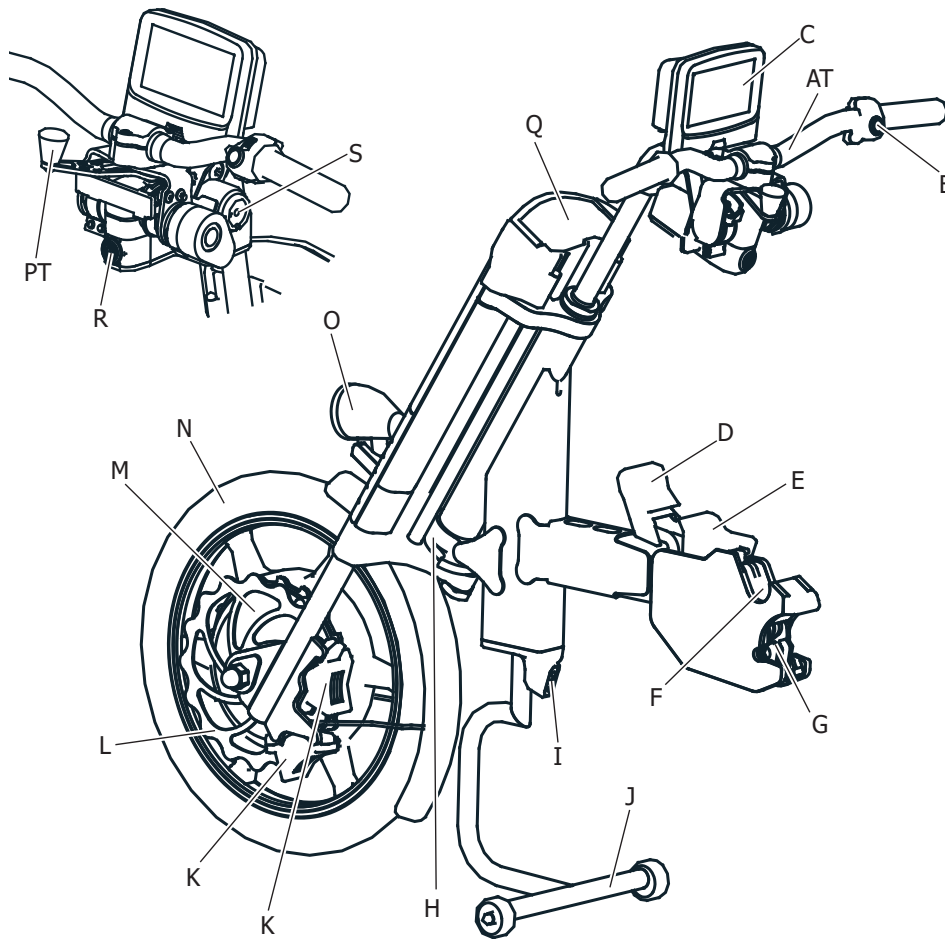

AT	Handle bar with throttle and brake function	J	Support legs
B	Reverse button	K	Brake caliper (x2)
C	Display	L	Brake disc
D	Locking handle	M	Drive motor
E	Release handle	N	Drive wheels
F	Upper docking mechanism	O	Front lighting
G	Lower docking mechanism	PT	Lock handlebar/Parkingbrake
H	Rotary lock	Q	Battery holder with battery
I	Rear lighting	R	Main switch
		S	Charging socket

Wheelchair coupling system

The docking mechanism (F) and (G) are located at the rear of the middle section and, together with the appropriate bar for the wheelchair, form the interface between Infinity and wheelchair. The locking handle (D) locks the docking mechanism and lifts the support legs (J). A release handle (E) is located adjacent to the docking mechanism.

Drive system

The drive system consists of drive motor (M) located in the drive wheel (N), battery with battery holder (Q), and charging socket (S).

Manoeuvre system Infinity

The manoeuvre system consists of throttle control (A), reverse button (B), start button (R), two brake levers (P), display (C) and handlebars.

Manoeuvre system Infinity Tetra

The manoeuvre system consists of handle bar with throttle and brake control (AT), reverse button (B), start button (R), and display (C)

Braking system Infinity

The braking system must be checked regularly at intervals of 6 (six) months.

The braking system on the Infinity consists of two individual hydraulic brake calipers (K) with associated brake handles (P) and brake disc (L). The brake fluid reservoirs are built into the brake levers. The brake disc and calipers are mounted on the drive wheel.

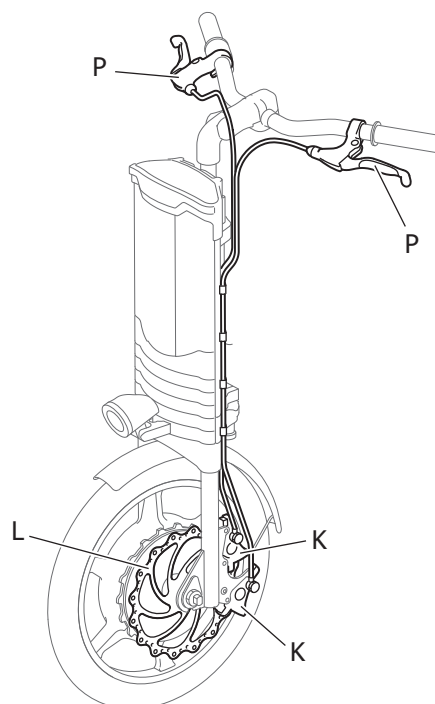

It is extremely important that the distance between the brake lever and the steering lever is not less than 15 mm when the brake lever is retracted as far as possible. Otherwise the braking capacity will not be sufficient

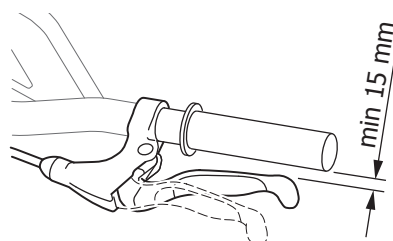

Braking system Infinity Tetra

The braking system must be checked regularly at intervals of 6 (six) months.

The braking system on the Infinity consists of two individual hydraulic brake calipers (K) with associated handle bar (AT) and brake disc (L). To activate the braking system the handle bar (AT) is pushed forward. The brake disc and calipers are mounted on the drive wheel.

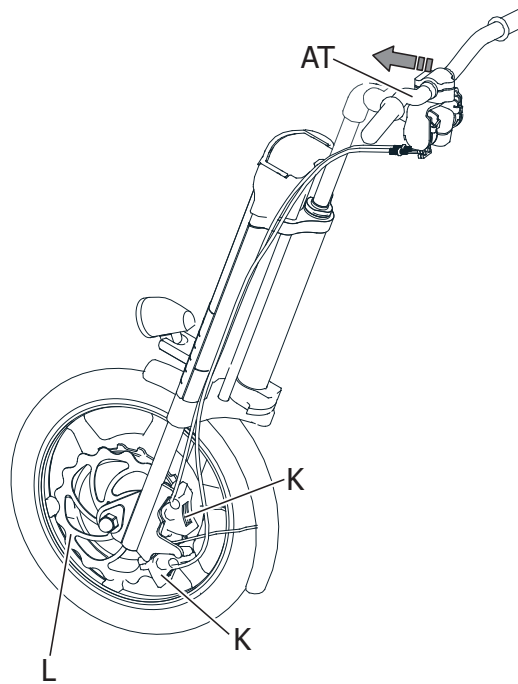

Lighting

The lighting consists of a headlight (O) with white front light and a red rear light (I). The lighting is switched on and off from the display (C).

Display

Infinity is equipped with a display that provides the user with information. This display also provides the electrical settings of Infinity. The screen on the display is a touchscreen. The display is equipped with a USB socket suitable for, for example, charging a mobile phone. Maximum power 10 W.

The display has two different themes to choose from, Standard and City.

Menu structure

Theme Standard

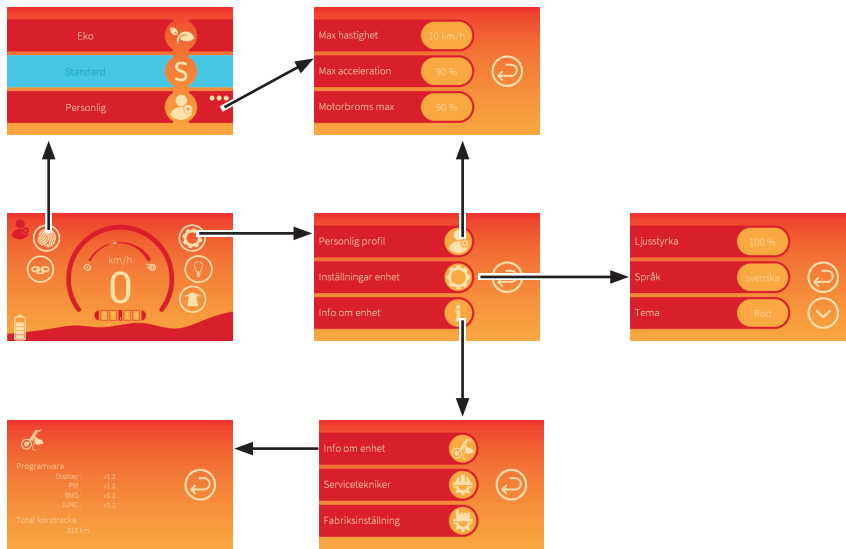

Theme City

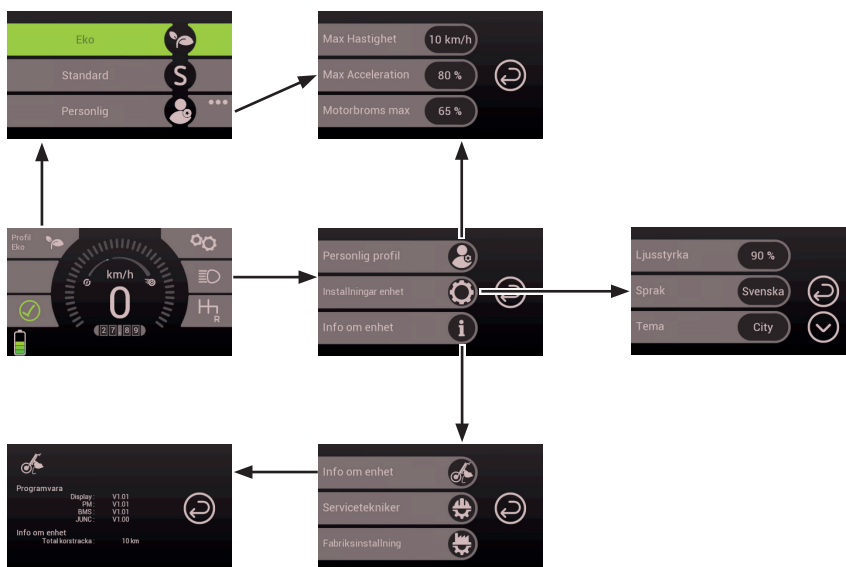

PIN code (Optional)

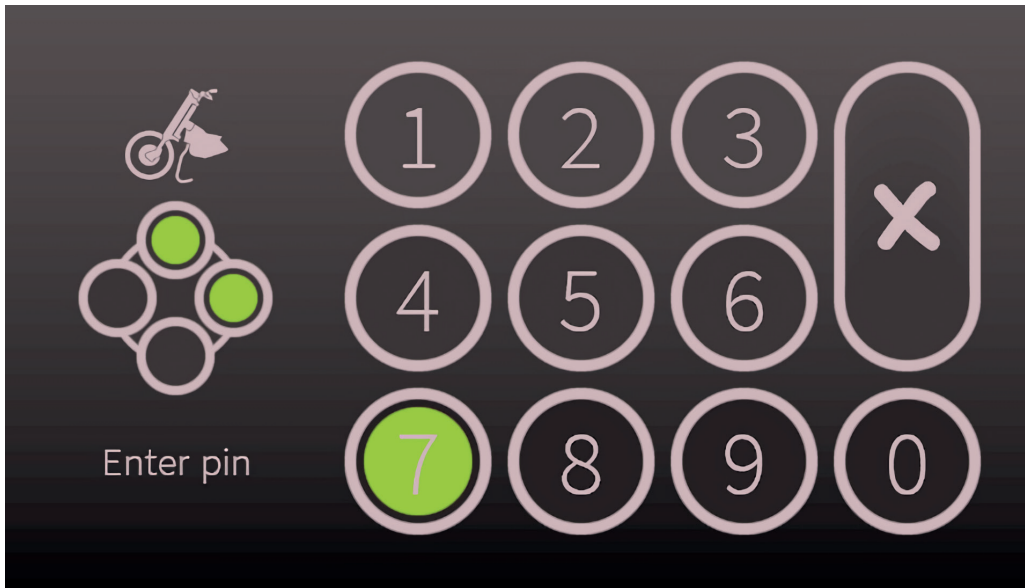

In some markets, Infinity is required to be protected with a PIN code. When starting Infinity, this PIN code will then be requested. When Infinity is delivered from the factory, the PIN code is: 0000. For each digit entered in the PIN code, a green dot will appear in the field to the left on the display. When all 4 digits have been entered, this field will show green if you have entered the correct PIN code and you will have access to Infinity. If the wrong PIN code has been entered, this field will flash red and then you can re-enter the PIN code

The user of the product can change the PIN code by going into device settings and selecting the PIN code menu. There are then instructions on the display on how to proceed to change the PIN code.

Activation and deactivation of the PIN code can only be done by a qualified service technician or the manufacturer of the product.

Home menu

Theme Standard

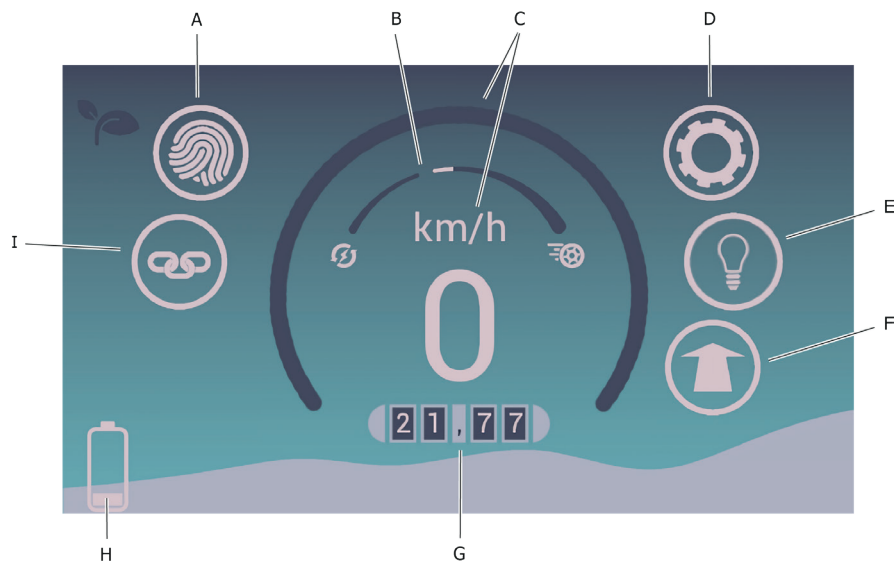

Theme City



- | | |
|--|-------------------------------------|
| A Button and indicator for driving profile | F Indication of direction of travel |
| B Energy flow indicator | G Trip counter |
| C Speedometer, analogue and digital | H Battery indicator |
| D Settings button | I Wheelchair lock indicator |
| E Button for lighting | |

A few seconds after activating Infinity, the home menu will appear on the display. While driving, the home menu shows information about the current battery level, speed, direction of travel and an indication that Infinity is locked to the wheelchair. There are also buttons for switching the lighting on and off, changing the driving profile and making settings.

When you press any of the buttons on the display, submenus will appear. There you can adjust the settings so that Infinity is adapted to your needs.

Pressing  takes you back a level in the menu structure. The button also saves a setting.

You can quickly get all the way back to the home menu by pressing and holding  for a few seconds.

Driving profile (A)

The symbol shows which driving profile is selected. Pressing the button takes you to the menu for selecting the driving profile.

- The eco-profile is aimed reducing energy consumption as much as possible. This is done by lowering acceleration and regenerating as much energy to the battery as possible.
- The standard profile is set to have maximum acceleration, speed and engine brake. This means that the range decreases.
- The personal profile can be changed in the settings menu.



Energy flow indicator (B)

The scale shows whether energy is being taken out of the battery or fed into the battery. During engine braking, for example, the engine will act as a generator and add charge to the battery.

Speedometer (C)

The symbol shows the current speed with analogue scale and digital display.

Settings (D)

A push of a button takes you to the settings menu. From this menu you can go further and change your personal driving profile and the unit's interface and get more information about Infinity.

Pressing each button takes you to the menu to view and change the settings.

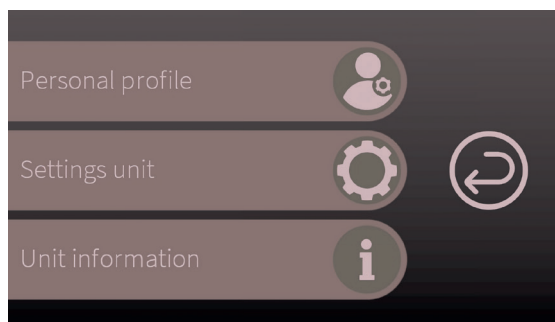

Personal driving profile

In the menu Personal driving profile you see current selections of maximum speed, acceleration and engine brake.

Press the button for the parameter you want to change.

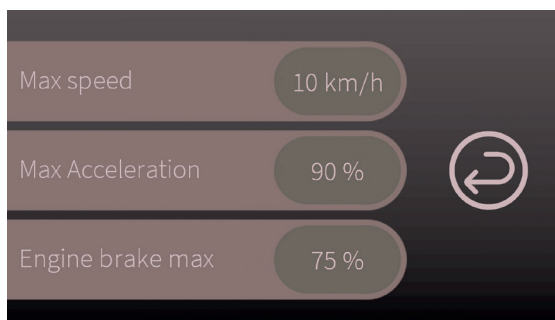

Maximum speed

Press the up arrow to increase or the down arrow to decrease the maximum speed in your personal driving profile.

Press  to save the setting and return to the Personal Driving Profile menu.



Acceleration

Press the up arrow to increase or the down arrow to decrease the maximum acceleration in your personal driving profile.

Press  to save the setting and return to the Personal Driving Profile menu.

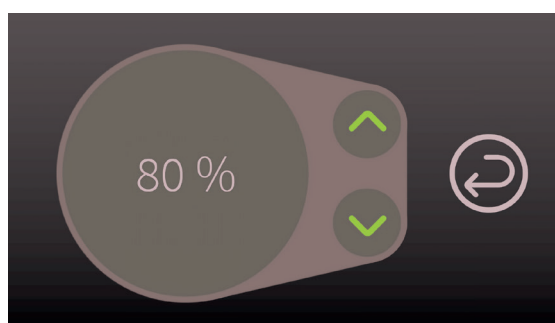

Engine brake

Press the up arrow to increase or the down arrow to decrease the effect on the engine braking in your personal driving profile.

Press  to save the setting and return to the Personal Driving Profile menu.



Device settings

Here you set the brightness of the display and select the language.

A theme can also be chosen.

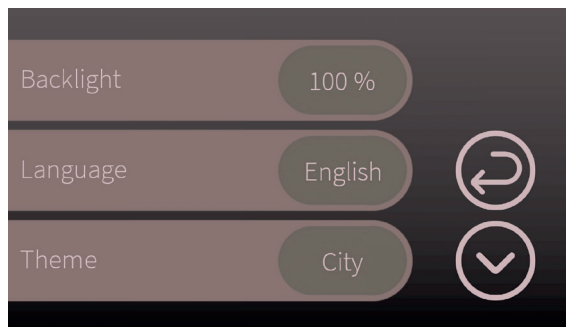

Adjustment of brightness

Press the up arrow to increase or the down arrow to decrease the brightness of the panel.

Press  to save the setting and return to the Device settings menu.



Language selection

Select the language by pressing the up or down arrow.

Press  to save the setting and return to the Device settings menu.



Theme

It is possible to choose between two different themes, Standard and City. Both themes have the option of selecting contrast setting suitable for people with colour blindness. Under the theme Standard there is possibility for different colour choices.



Select the theme by pressing the up or down arrow.

Press  to save the setting and return to the Device settings menu.

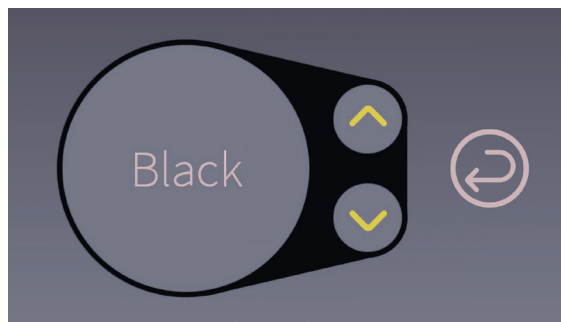

Info about the device

The information and status box about Infinity is displayed here. From this menu, service technicians and the factory can move on to the settings that only they have access to.

Press  to return to the Settings menu.

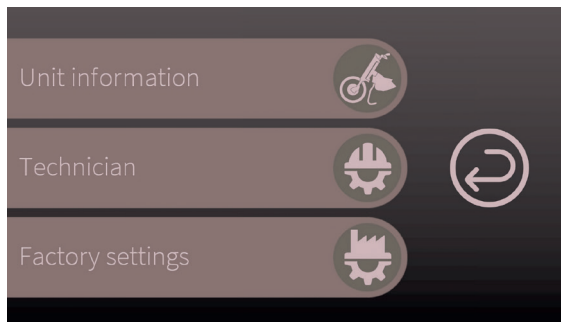

Lighting (E)

Use the button to switch the Infinity lighting on and off. Both the front and rear lights are switched on and off at the same time. The button is blue when the lighting is on.

Driving direction display (F)

The symbol shows the direction of travel.

Infinity Standard:

Forward arrow shows forward travel.
Rear arrow shows reverse.

Infinity City:

Grey symbol indicates driving forward.
Green arrow shows reverse.

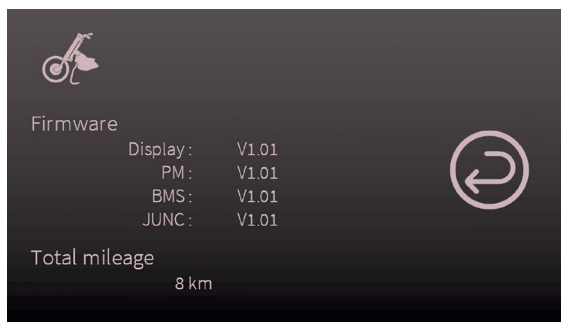

Trip counter (G)

The trip counter shows the total completed mileage. Resetting is done by pressing the numbers on the trip counter.

Battery indicator (H)



The symbol shows the current battery level. When the battery indicator shows one bar remaining, 5 km mileage remains.

**WARNING!**

Check the remaining battery capacity before crossing a street or road. If the remaining battery capacity is low, Infinity may stop.

Lock indicator (I)

The symbol indicates that Infinity is locked to the wheelchair's adapter bar.

Infinity Standard: Three connected links  show that Infinity is correctly docked to the adapter bar on the wheelchair and locked with the locking handle. Two, unconnected, links  indicate that Infinity is not properly connected to the adapter beam.

Infinity City: Green symbol indicates that Infinity is correctly docked to the adapter bar on the wheelchair and locked with the locking handle. White symbol indicates that Infinity is not properly connected to the adapter bar.

You can not drive without Infinity correctly connected to your wheelchair.

Mechanical settings Infinity

The handlebars and steering column on Infinity are adjustable. By adjusting the steering column, the height and angle of the handlebar can be changed.

Height adjustment

1. Loosen the screw that secures the steering column with a 6 mm Allen key.
2. Move the steering column to the desired height.
3. Tighten the screw to hold the steering column in place.

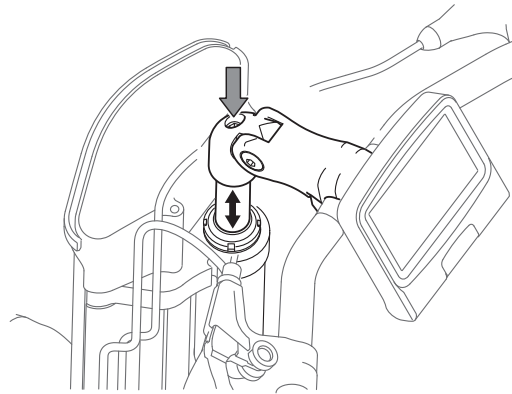

WARNING!

It is extremely important that all screws are tightened correctly after installation.

Angle adjustment

1. Loosen the upper screw that locks the angle adjustment with a 5 mm Allen key. If necessary, hold with a 5 mm Allen key on the opposite side.
2. Then loosen the lower screw that locks the angle adjustment with a 5 mm Allen key.
3. Adjust the angle of the steering column.
4. Tighten all screws to hold the handlebars in place.

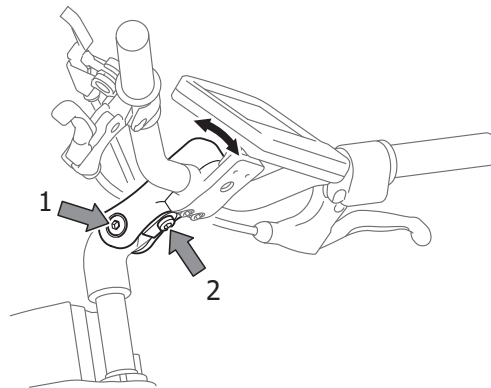

WARNING!

It is extremely important that all screws are tightened correctly after installation.

Adjusting the handlebars

1. Loosen the three screws that lock the handlebars in the steering column with a 5 mm Allen key.
2. Turn the handlebar to the desired position.
3. Tighten all screws to hold the handlebars in place.

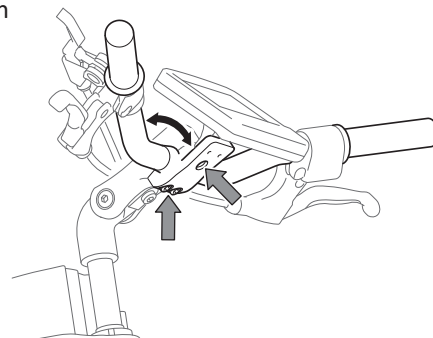

WARNING!

It is extremely important that all screws are tightened correctly after installation.

Mechanical settings Infinity Tetra

The handlebars and steering column on Infinity Tetra are adjustable. By adjusting the steering column, the height of the handlebar can be changed

Height adjustment

1. Loosen the screw that secures the steering column with a 6 mm Allen key.
2. Move the steering column to the desired height.
3. Tighten the screw to hold the steering column in place.



WARNING!

It is extremely important that all screws are tightened correctly after installation.

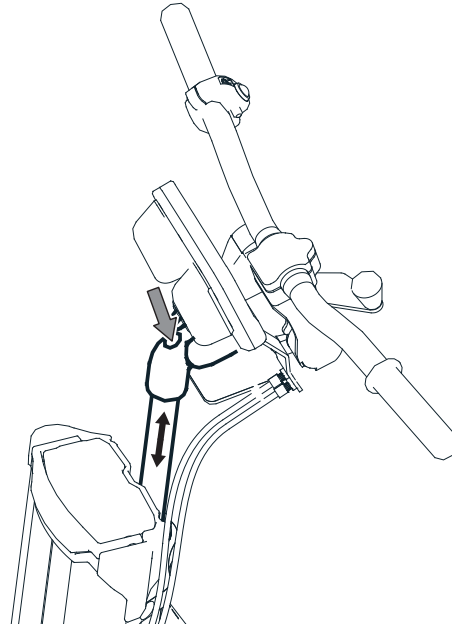

Adjusting the handlebar

1. Loosen the three screws that lock the handlebars in the steering column with a 4 mm Allen key.
2. Turn the handlebar to the desired position.
3. Tighten all screws to hold the handlebars in place.



WARNING!

It is extremely important that all screws are tightened correctly after installation.

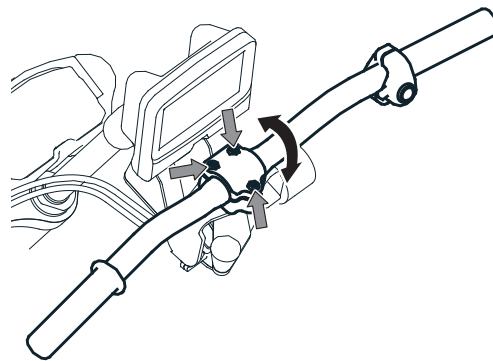

Using Infinity and Infinity Tetra

Your wheelchair must be equipped with a Decon Infinity adapter bar in order being able to connect Infinity to the wheelchair. The adapter bar must be installed by a trained technician.



WARNING!

The user must have read and understood the manual and have an understanding of the various controls and user interfaces that Infinity is equipped with.



WARNING!

Be careful when connecting the Infinity to the wheelchair and lifting the castors off the ground, step 4 in "Connecting the Infinity to your wheelchair" on page 29. Feet can get trapped between the arch / footrest on the wheelchair and Infinity. Feet and toes may then be injured.



WARNING!

Do not place your fingers or hands under the locking handle when this is lowered, step 5 in "Connecting Infinity to your wheelchair" on page 29. If you do, you may trap your finger (s) or the whole hand.

Connecting Infinity to your wheelchair

1. Align the Infinity and wheelchair so that the docking point on the Infinity (F, G) is in the middle of the docking point on the wheelchair's adapter beam. Drive the wheelchair forwards until the adapter bar on the wheelchair is in contact with the docking point on Infinity.
2. Grasp the handlebars on the Infinity and pull it diagonally downwards to come under the adapter bar. When the upper docking point has passed under the adapter bar, Infinity can be pushed slightly upwards to feel that the upper docking point (F) has hooked into the adapter bar. In this position, the upper docking point only rests against the adapter bar, they are not connected to each other.
3. Check that Infinity is connected to the wheelchair by lightly pushing Infinity away from the wheelchair using the handlebar.

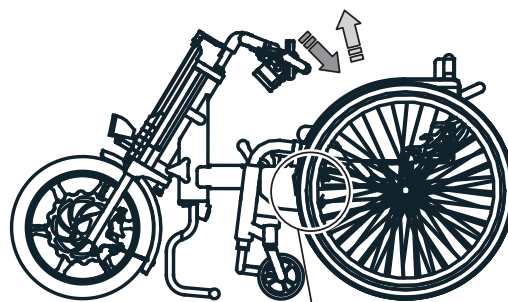
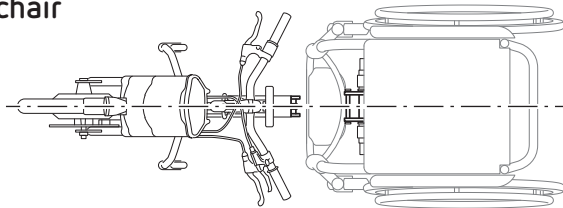

- Push the handlebars on the Infinity at an angle upwards while leaning slightly backwards to lift the wheelchair's castors from the ground and lock the Infinity against the lower dock (G). When Infinity is connected to the lower docking point, a clicking sound is heard.

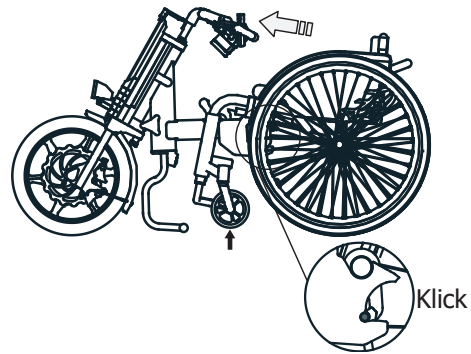

- First push the locking handle (D) forward to release it. Then slide it back to lock the Infinity to the adapter bar. The support legs (J) are now raised.

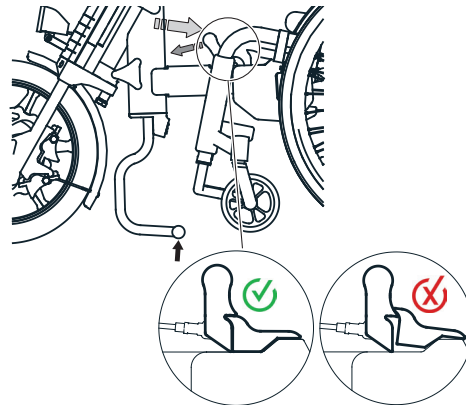

Check that the locking handle (D) and release handle (E) ends up in the correct position.

Now Infinity is ready to go.

To disconnect Infinity

- Switch off Infinity using the main switch (R).
- Lower the locking lever (D) until you hear a **click**. NOTE! If the locking handle is moved too far, it will not lock in its lowered position. The support legs are now folded down but do not reach the ground.
- Fold up the release handle (E) to its open position to prepare the release.
- Now push the handlebar forward while leaning back to unlock the lower docking point (G). When the lower docking point is unlocked, a click is heard. Now drop the wheelchair's castors to the ground.
- To completely release the Infinity from the chair, pull the Infinity at an angle towards you and then push the Infinity at an angle downwards away from you.

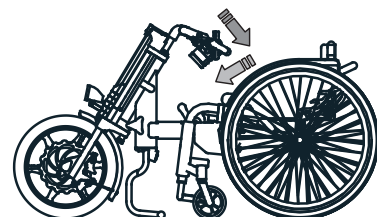
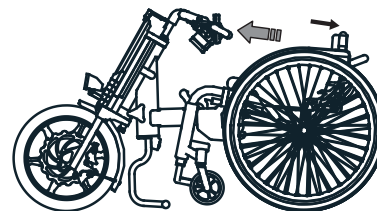
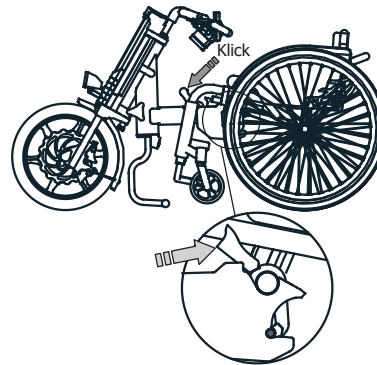



WARNING!

The user must have read and understood the manual and have an understanding of the various controls and user interfaces that Infinity Tetra is equipped with.



WARNING!

Be careful when connecting Infinity Tetra to the wheelchair and lifting the castors off the ground, step 5 in "Connecting Infinity Tetra to your wheelchair" on page 31. Feet can get trapped between the arch / footrest on the wheelchair and Infinity Tetra. Feet and toes may then be injured.



WARNING!

Do not place your fingers or hands under the locking handle when this is lowered, step 6 in "Connecting Infinity Tetra to your wheelchair" on page 31. If you do, you may trap your finger (s) or the whole hand.

Connecting Infinity Tetra to your wheelchair

1. Align the Infinity Tetra and wheelchair so that the docking point on the Infinity Tetra (F, G) is in the middle of the docking point on the wheelchair's adapter beam. Drive the wheelchair forwards until the adapter bar on the wheelchair is in contact with the docking point on Infinity Tetra.

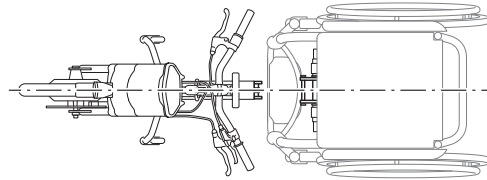

2. Activate the parking brake so that the handle bar cant be moved downwards. See also chapter "Parking brake Infinity Tetra" page 34.

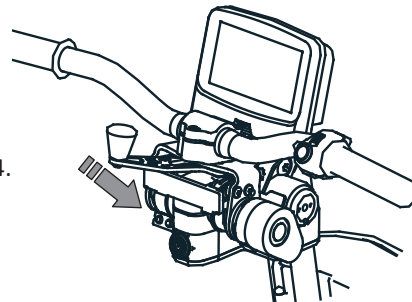

3. Grasp the handlebars on Infinity Tetra and pull it diagonally downwards to come under the adapter bar. When the upper docking point has passed under the adapter bar, Infinity Tetra can be pushed slightly upwards to feel that the upper docking point (F) has hooked into the adapter bar. In this position, the upper docking point only rests against the adapter bar, they are not connected to each other.

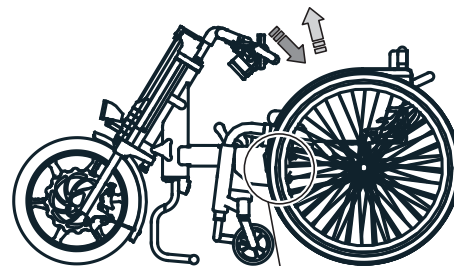

4. Check that Infinity Tetra is connected to the wheelchair by lightly pushing Infinity Tetra away from the wheelchair using the handlebar.



5. Push the handlebars on Infinity Tetra at an angle upwards while leaning slightly backwards to lift the wheelchair's castors from the ground and lock Infinity Tetra against the lower dock (G). When Infinity Tetra is connected to the lower docking point, a clicking sound is heard.

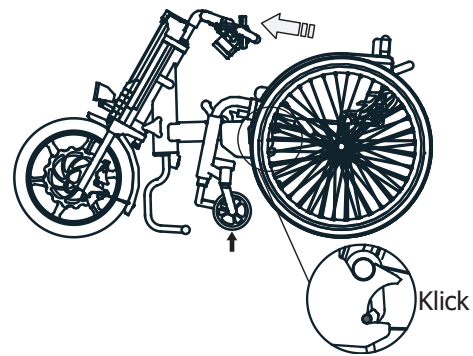

6. First push the locking handle (D) forward to release it. Then slide it back to lock Infinity Tetra to the adapter bar. The support legs (J) are now raised.

INFO

Check that the locking handle (D) and release handle (E) ends up in the correct position.

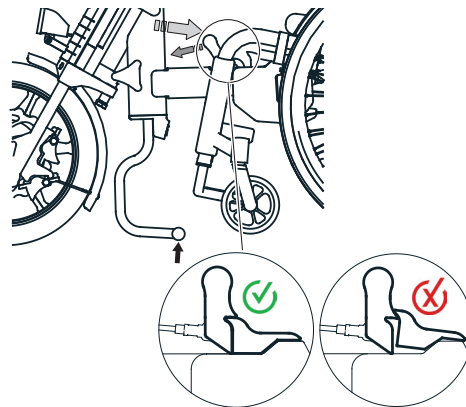

7. Deactivate the parking brake by moving the lever to the left and the slightly pushing the handle bar forward until you hear a "click". The release the handle bar and return to neutral position.

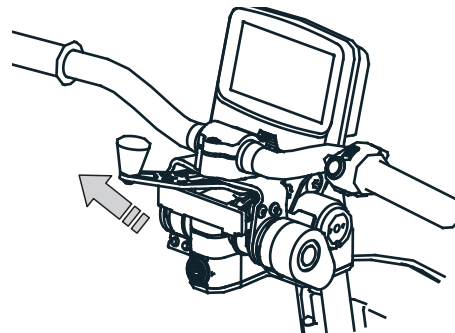

Now Infinity Tetra is ready to go.

To disconnect Infinity Tetra

1. Switch off Infinity Tetra using the main switch (R).
2. Activate the parking brake so that the handle bar cant be moved downwards. See also chapter "Parking brake Infinity Tetra" page 34

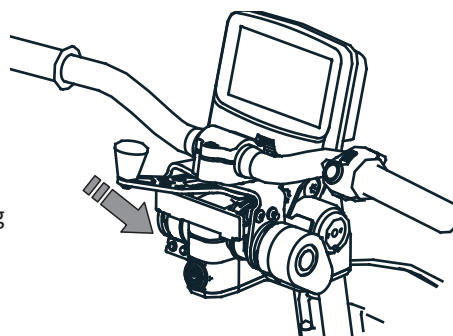

3. Lower the locking lever (D) until you hear a **click**. NOTE! If the locking handle is moved too far, it will not lock in its lowered position. The support legs are now folded down but do not reach the ground.

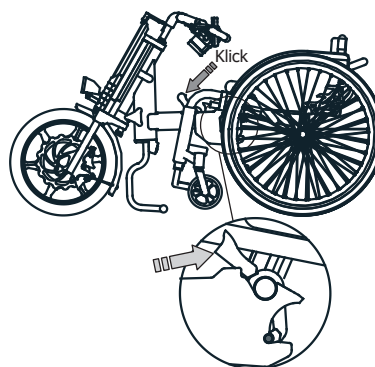

4. Fold up the release handle (E) to its open position to prepare the release.

5. Now push the handlebar forward while leaning back to unlock the lower docking point (G). When the lower docking point is unlocked, a click is heard. Now drop the wheelchair's castors to the ground.

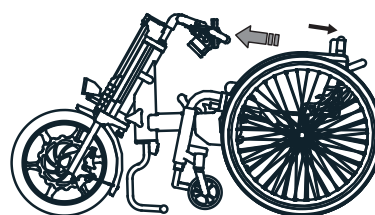

6. To completely release Infinity Tetra from the chair, pull Infinity Tetra at an angle towards you and then push Infinity Tetra at an angle downwards away from you.

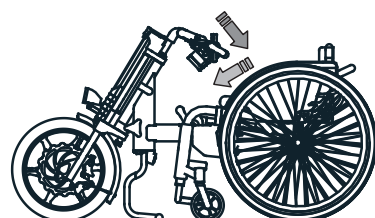

To remove and install the adapter bar

In order to be able to fold a cross frame chair, you need to remove the adapter bar.

1. Remove the QR pins that hold the adapter bar in place in its holders.
2. Slide the adapter bar out of its holders.

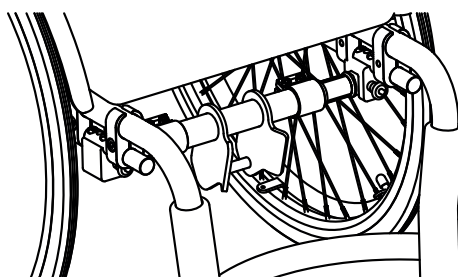

Reassembly follows the reverse order



WARNING!

Ensure that the adapter bar is properly fixed with the QR pins.

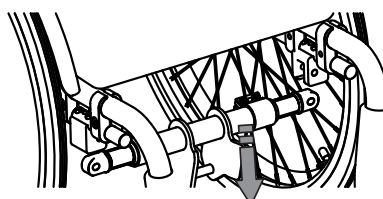
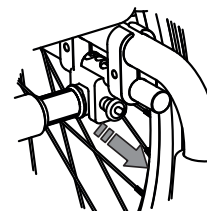

Running Infinity



WARNING!

The user must have read and understood the manual and have an understanding of the various controls and user interfaces that Infinity is equipped with.



WARNING!

Do not make sharp turns at high speed. This may cause Infinity and the wheelchair to tip over.

To run Infinity, you must first have Infinity connected to the wheelchair according to the section "Connecting Infinity to your wheelchair"

1. Press the main switch located below the display. The light in the main switch will flash on start up. When the light is solid, Infinity is ready to go.
2. Use the throttle control to move forwards. When reversing, the reverse button located next to the throttle control is used.
3. Turn the throttle control to drive and regulate the speed.

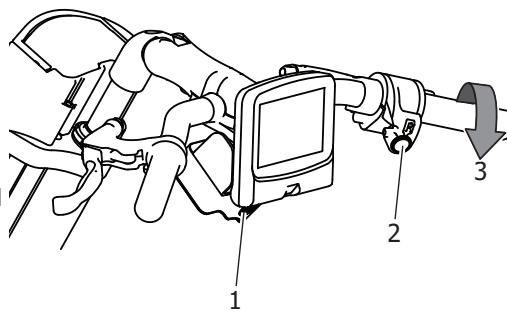

Speed control is primarily controlled by means of the throttle control.



WARNING!

When driving on a steep descent, it may be necessary to apply the brakes to limit the speed. Engine braking is only effective to a certain extent.

Parking brake Infinity

Infinity is equipped with a parking brake on the left brake lever as standard. The parking brake is able to keep Infinity still on a level surface. When parking on a sloping surface, the parking brake must be combined with the wheelchair's brakes to ensure that the Infinity and wheelchair do not start rolling.



INFO

Use the parking brake when you are stopped at, for example, a traffic light or a pedestrian crossing.

Running Infinity Tetra



WARNING!

The user must have read and understood the manual and have an understanding of the various controls and user interfaces that Infinity Tetra is equipped with.



WARNING!

Do not make sharp turns at high speed. This may cause Infinity Tetra and the wheelchair to tip over.

To run Infinity Tetra, you must first have Infinity Tetra connected to the wheelchair according to the section "Connecting Infinity Tetra to your wheelchair"

1. Press the main switch located below the display. The light in the main switch will flash on start up. When the light is solid, Infinity Tetra is ready to go.
2. Driving forward is done by pushing the handle bar downwards. Braking is done by pushing the handle bar forward.
3. To drive backwards use the reverse button located on the handle bar.

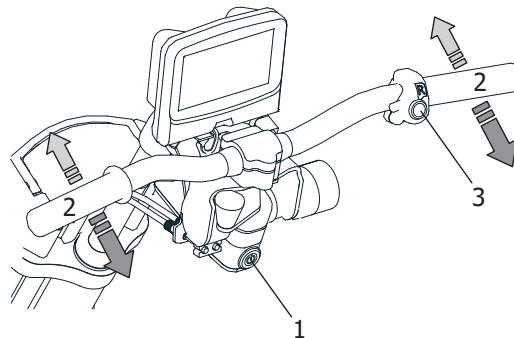

Speed control is primarily done by bringing the handle bar towards the user.



WARNING!

When driving on a steep descent, it may be necessary to apply the brakes to limit the speed. Engine braking is only effective to a certain extent.

Parking brake Infinity Tetra

Infinity Tetra is equipped with a parking brake. Parking brake is activated by moving the lever (PT) towards the center and then pushing the handlebar (AT) forward. To deactivate parking brake the lever (PT) is moved to the left and the handlebar (AT) is pushed slightly forward until a "click" sound appears. The parking brake is able to keep Infinity Tetra still on a level surface. When parking on a sloping surface, the parking brake must be combined with the wheelchair's brakes to ensure that Infinity Tetra and wheelchair do not start rolling.

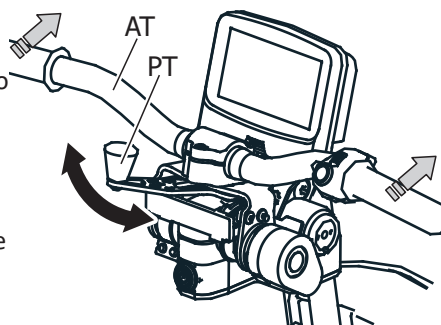

INFO

Use the parking brake when you are stopped at, for example, a traffic light or a pedestrian crossing.

Techniques for passing obstacles and driving uphill.

Passing obstacles

It may be difficult to pass an obstacle when keeping the wheel in contact with the obstacle. To pass obstacles, it is recommended to pause about 0.5 m in front of the obstacle and accelerate towards it (e.g. curb, road edge, etc.).

When experiencing difficulty to pass an obstacle the user may also, if possible, manually help by using the wheelchairs pushrim and at the same time activate the throttle control.

Driving uphill

When driving up a steep hill (more than 4-5 degrees incline) it is recommended to move the centre of gravity as far forward as possible by tilting the upper body forward and if possible moving further forward on the wheelchair seat. By moving the centre of gravity forward, Infinity gets better tyre traction.

Another alternative driving technique if the conditions and surroundings allow it, is to drive S-turns up the hill.

Moving Infinity connected to a wheelchair

To move the Infinity when connected to a wheelchair, turn off the main power switch. The drive wheel is then disengaged and can roll without power.



WARNING!

Never drive Infinity when not seated in the wheelchair.

Transport of Infinity



WARNING!

Use straps to ensure that Infinity can be transported safely.



WARNING!

Infinity must never be transported when coupled with the wheelchair. In vehicles where the wheelchair is used as a seat, the Infinity must be disconnected from the wheelchair and placed in the luggage compartment or equivalent and load secured.



CAUTION!

Position Infinity so that no parts are damaged during transport.

Loading Infinity into a car

1. Turn the power to Infinity off.
2. Remove the battery from Infinity to prevent the power from suddenly turning on during storage or transport. Be sure to put the protective cap on the removed battery.



WARNING!

Always store the disconnected battery with the protective cover on. Exposed contacts can cause a short circuit, fire or battery rupture.

3. Load Infinity into the car.
 - a. Lift the Infinity by the steering column and front wheel when loading.
 - b. Be careful not to damage the display during loading.
4. Securing Infinity.
 - a. Secure Infinity to prevent it from moving while travelling, and hitting objects in its surrounding.



Tips when loading

- The product contains sensitive electronic components. Do not subject the product to strong, directed shocks or blows.
- Load as upright as possible.
- If you load Infinity lying down, make sure that the display cannot be damaged before securing the load.

Tips for securing loads

- Secure Infinity with straps and place shock-absorbing materials under and around Infinity.

Boarding an aircraft

When you book a flight, you should always inform the airline in advance that you are bringing an electric drive unit for a wheelchair and follow their instructions. Give the airline detailed information about this at the time of booking. When flying, the standard battery can not be used, but you must use a Travelpack battery with lower capacity that has the following specifications:

Name:	Battery Travelpack Infinity
Article number:	LBM1002
Voltage:	48 V
Capacity:	6 Ah (288 Wh)
Type:	Dry cell with built-in microcomputer

It may be forbidden to bring the lithium ion battery on board and to check it in as hand luggage. Always consult the airline in advance.

Storing Infinity

1. Turn off the power and remove the battery
2. Store Infinity in a place with normal indoor temperature and low humidity.
3. To wipe off dirt or stains before storage, use a tightly wrung out towel.

If Infinity is not to be used for a long time, leave the battery in the machine but with the power off. Check that Infinity is working properly every month.

After storing Infinity, check and perform the following before using it:

- Reactivate the battery by connecting the charger
- Battery status, charge as necessary
- Brake function, check that these work and are not resting against the brake disc.

Battery and charger

Ambient temperatures for the battery

When used on Infinity	-15 ° C - 40 ° C
For storage, removed from Infinity	10 ° C - 25 ° C
When charging	5 ° C - 30 ° C

Charging the battery for Infinity can be done either with the battery in or out of the battery holder on Infinity.

When charging with the battery in the battery holder, connect the charger's magnetic contact to the socket on the side of the junction box below the display.

With the battery removed, use the custom adapter with the charger.



WARNING!

Be careful not to get your finger trapped when inserting or removing the battery.

The Infinity charger is equipped with a light to show the charging status. When the charger is connected to the wall socket and the lamp shows a green light, the charger can be connected to the charging socket.

When the charger is connected to the charging socket and the battery is charging, the charger shows a red light.

When the battery is fully charged, the light is green. A fully discharged battery can take up to 5 hours to charge fully.

Charging the battery in Infinity

1. Connect the charger to a wall socket.
2. Check that the lamp on the charger is green.
3. Connect the magnetic plug to the charging socket at the display. Make sure that the lug on the cable connector fits into the slot on the socket.



INFO

Check that the lamp on the charger is red.
This indicates that charging is in progress.

4. When charging is complete, disconnect the charger from the Infinity and the wall socket.

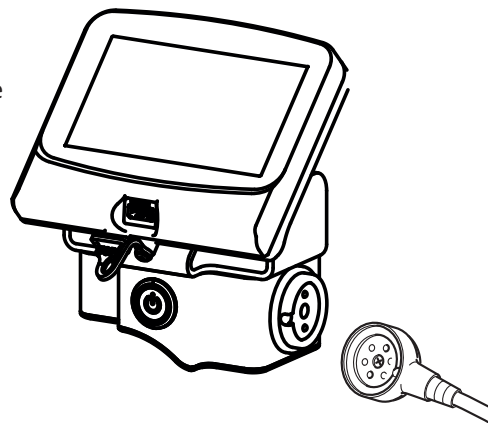

Charging the battery removed from the Infinity

1. Fold up the handle and lift the battery out of the holder.

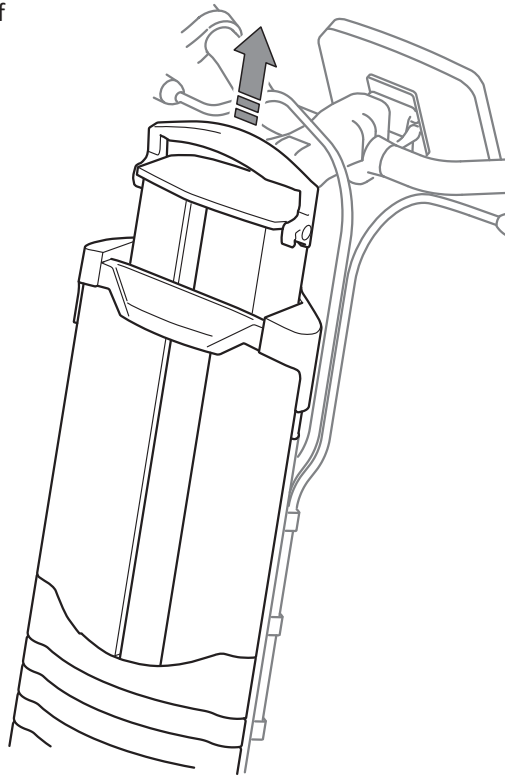

2. Connect the adapter to the battery connector.
3. Connect the charger to a wall socket.
4. Check that the lamp on the charger is green.
5. Connect the magnetic plug to the charging socket on the charging adapter. Make sure that the lug on the cable connector fits into the slot on the socket.

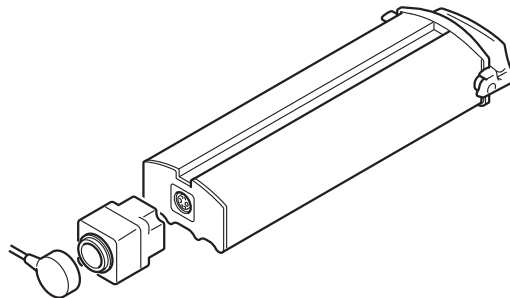

INFO

Check that the lamp on the charger is red. This indicates that charging is in progress.

6. When charging is complete, disconnect the charger from the charging adapter and from the wall socket.
7. Disconnect the charging adapter from the battery connector and put the battery back in the holder on the Infinity. Lower the handle so that the battery locks securely.

Battery storage

Store the batteries in a cool and dry place (a place with a temperature between 10-25°C is optimal for storage). If you plan not to use Infinity for a long time (one month or longer), charge the battery until three of the charge level bars appear on the display before storing it. **If the battery is not used for a long time, it will automatically enter storage mode if the voltage level in the battery is not too high. If the battery has entered storage mode, it must be reactivated by putting it on charge.** Check every 3 months that the voltage in the battery has not dropped to too low a level. If one or no battery bars are displayed, charge the battery until 3-4 bars are displayed on the charge level.

Care

Cleaning

If Infinity becomes dirty due to normal use, clean Infinity with a lightly damp towel. If Infinity is heavily soiled, use a towel and a neutral detergent. Make sure that no detergent remains on Infinity after cleaning.

! CAUTION!

Never wash Infinity with a hosepipe or high pressure washer. Do not use steam a cleaner to clean Infinity. The electronic devices may be damaged, which can lead to serious malfunctions.

! CAUTION!

Do not clean with solvents such as petrol or thinner. This may damage paint and plastic parts on Infinity



A cloth and alcohol-based sanitiser is suitable to disinfect Infinity.

Corrosion

All Infinity parts that can be exposed to corrosion are made of aluminium, stainless steel or steel. The materials and the transitions between the materials have been surface treated, therefore there is no increased risk of corrosion. Regardless of this, you should always wipe wet or damp surfaces on Infinity with a dry cloth after use.

Maintenance

Use a copy of this page to note when and by whom the checks were performed. Save the details.

The following checks should be performed every 6 months after the first use.

Unit	Action	Date	Controller
Overview	Noise, jammed parts		
	Check of locking against the adapter bar on the wheelchair		
	Tyre pressure and wear		
	Looseness in drive, damage, dangerous damage sharp edges		
	Check, tighten screws		
	Dirty battery contacts		
	Cables, visual inspection for damage		
	Cables, check connections		
Battery and charger	Cables, visual inspection for damage		
	Cables, check connections		
	Battery, visual inspection for damage		
Brakes Infinity	Brake hose, visual inspection for damage		
	Brake disc, visual inspection for damage		
	Brake caliper, visual inspection for damage and leakage		
	Brake caliper, tightening of screws		
	Brake handle, visual inspection for damage and leakage		
	Brake lever, tightening of screws		
Brakes Infinity Tetra	Brake wire, visual inspection for damage		
	Brake disc, visual inspection for damage		
	Brake caliper, visual inspection for damage		
	Brake caliper, tightening of screws		
	Brake function handle bar, visual inspection for damage		
	Brake function handle bar, tightening of screws		

Repairs

- The user must not repair or service Infinity himself.
- The user must not remove and send parts of Infinity to the dealer for repair.
- If repair is required, contact your dealer even if the fault is of a less serious nature.
- If parts are damaged or missing, contact your dealer immediately. Return Infinity to your dealer to have parts replaced or repaired.
- For normal maintenance, repair or service, always contact your dealer. If Infinity is not repaired or all parts are not used during assembly, the user, people in its surroundings or property may be injured.
- To carry out repairs and service, the dealer uses the service manual, spare parts catalogue and other documentation. This documentation is not available to the user and the public.

Puncture



The tyre on Infinity has the same structure as a bicycle tyre. Therefore, usually, a bicycle workshop can repair a puncture and change tyres on Infinity. If you do not have access to a bicycle workshop, contact your dealer.

Reuse

When Infinity is to be transferred to a new user, all technical documentation must also be transferred.

The product must be cleaned by a professional, disinfected and serviced.

Waste disposal

When Infinity has expired and is to be scrapped, contact your local authorities for recycling information and follow their instructions.

Alternatively, you can contact your dealer for recycling of your used Infinity and its battery.

Troubleshooting

Error descriptions

Use the table below for troubleshooting before contacting your dealer.

Status	Lamp in main switch	Taillight	Audio signal	Checkpoint	Action
The Infinity display does not start when the main switch is turned on.	Light off	-	No	Make sure the battery is charged	Charge the battery
	Light off	-	No	Is the battery properly installed?	Check that the battery is properly installed
	Light off	-	No	Electrical connection / contact / cable between front and electric box under display	Press the coupling together with the arrows pointing towards each other
	Flashes once	Flashes once	No	Check that the cables are securely fastened to the back of the display	Install the cable correctly on the back of the display.
Does not respond to throttle controls	Steady light	-	No	Is the support leg raised and the locking handle in its rear position?	Move the locking handle to its rear position.
	Steady light	-	No	No indication on the display that Infinity is locked to the chair?	Move the locking handle to its rear position.
	Steady light	-	No	No indication on the display that Infinity is locked to the chair even though the locking handle is in its rear position.	Check that nothing is preventing the support leg from moving upwards to its upper position.
	Steady light	-	No	Check that the throttle control cable is firmly attached to the back of the display.	Install the cable correctly on the back of the display
	Steady light	-	No	Check that the contacts between motor and Power module are connected.	Connect the connector between motor and Power module.
Infinity cannot be docked against the chair's adapter	-	-	-	Uneven ground	Move Infinity and wheelchair to a smoother surface
	-	-	-	The height setting of Infinity has changed	Adjust the height and leg rests of the Infinity to fit the current adapter used to connect to the wheelchair.
	-	-	-	The lower docking mechanism has been pushed into its locked position	Pull the release handle to unlock the lower docking mechanism.

Error codes

Error code	Error explanation	Action
C6CB N: 01	Communication error Power module	Check the cable between the Power module and the display. Restart Infinity using the main power switch. If the error persists, contact your dealer.
C6CB N: 02	Communication error BMS / Battery	Check that the battery is properly inserted in the machine. Restart Infinity using the main power switch. If the error persists, contact your dealer.
C6CB N: 03	Communication error Junction box	Check the cable between the front and junction box under the display. Restart Infinity using the main power switch. If the error persists, contact your dealer.
ABBE N: 01	Overcurrent protection 1 Power module	Restart Infinity using the main power switch. If the error persists, contact your dealer.
ABBE N: 02	Overcurrent protection 2 Power module	Restart Infinity using the main power switch. If the error persists, contact your dealer.
ABBE N: 03	Overcurrent protection Power module	Restart Infinity using the main power switch. If the error persists, contact your dealer.
ABBE N: 04	General fault monitoring triggered	Restart Infinity using the main power switch. If the error persists, contact your dealer.
ABBE N: 05	Communication error	Restart Infinity using the main power switch. If the error persists, contact your dealer.
ABBE N: 06	Power module overheated	Turn off Infinity and wait 5 min Start Infinity using the main switch. If the error persists, contact your dealer.
ABBE N: 07	Hall sensor error	Check that the connection between the motor and the Power module is properly connected Start Infinity using the main switch. If the error persists, contact your dealer.
ABBE N: 08	Short circuit of phases in the motor	Check that the connection between the motor and the Power module is properly connected and that the cable is not damaged Start Infinity using the main switch. If the error persists, contact your dealer.
2090 N: 01	Data errors in communication	Restart Infinity using the main power switch. If the error persists, contact your dealer.
2090 N: 02	Communication error	Restart Infinity using the main power switch. If the error persists, contact your dealer.
7F42 N: 01	Data errors in communication	Restart Infinity using the main power switch. If the error persists, contact your dealer.
7F42 N: 02	Data errors in communication	Restart Infinity using the main power switch. If the error persists, contact your dealer.
7F42 N: 03	Data errors in communication	Restart Infinity using the main power switch. If the error persists, contact your dealer.
7F42 N: 04	Data errors in communication	Restart Infinity using the main power switch. If the error persists, contact your dealer.
2DF1 N: 01	The battery is not ready	Restart Infinity using the main power switch. If the error persists, contact your dealer.
2DF1 N: 02	Communication with the battery was lost	Restart Infinity using the main power switch. If the error persists, contact your dealer.

Error code	Error explanation	Action
2DF1 N: 03	The battery is hot, the engine brake and charging are switched off	If possible, move the battery to a cooler place. Wait 10min. Restart Infinity using the main power switch. If the error persists, contact your dealer.
2DF1 N: 04	The battery is cold, the engine brake and charging are switched off	If possible, move the battery to a warmer location. Wait 30min. Restart Infinity using the main power switch. If the error persists, contact your dealer.
2DF1 N: 05	Overcurrent protection BMS / Battery	Restart Infinity using the main power switch. If the error persists, contact your dealer.
2DF1 N: 06	Short circuit BMS / Battery	Restart Infinity using the main power switch. If the error persists, contact your dealer.
2DF1 N: 07	Surge protection BMS / Battery	Restart Infinity using the main power switch. If the error persists, contact your dealer.
2DF1 N: 08	Under voltage protection BMS / Battery	Restart Infinity using the main power switch. If the error persists, contact your dealer.
2DF1 N: 09	BMS / Battery pre-charge failed	Restart Infinity using the main power switch. If the error persists, contact your dealer.
2DF1 N: 10	Battery too hot, all functions are switched off	Move the battery to a cooler place. Wait 30min. Restart Infinity using the main power switch. If the error persists, contact your dealer.
2DF1 N: 11	Battery too hot, all functions are switched off	Move the battery to a warmer location. Wait 60min. Restart Infinity using the main power switch. If the error persists, contact your dealer.
2DF1 N: 12	Battery unbalanced	Restart Infinity using the main power switch. If the error persists, contact your dealer.
1337 N: 01	Short circuit throttle control	Check wiring for throttle control Restart Infinity using the main power switch. If the error persists, contact your dealer.
1337 N: 02	Switch fault throttle control	Check wiring for throttle control Restart Infinity using the main power switch. If the error persists, contact your dealer.
1337 N: 03	Switch fault throttle control	Check wiring for throttle control Restart Infinity using the main power switch. If the error persists, contact your dealer.

Decon Wheel AB
Södra Ekeryd 119, 314 91 Hyltebruk
Tel: +46 (0) 345 40880
Fax: +46 (0) 345 40895
Email: info@decon.se

