

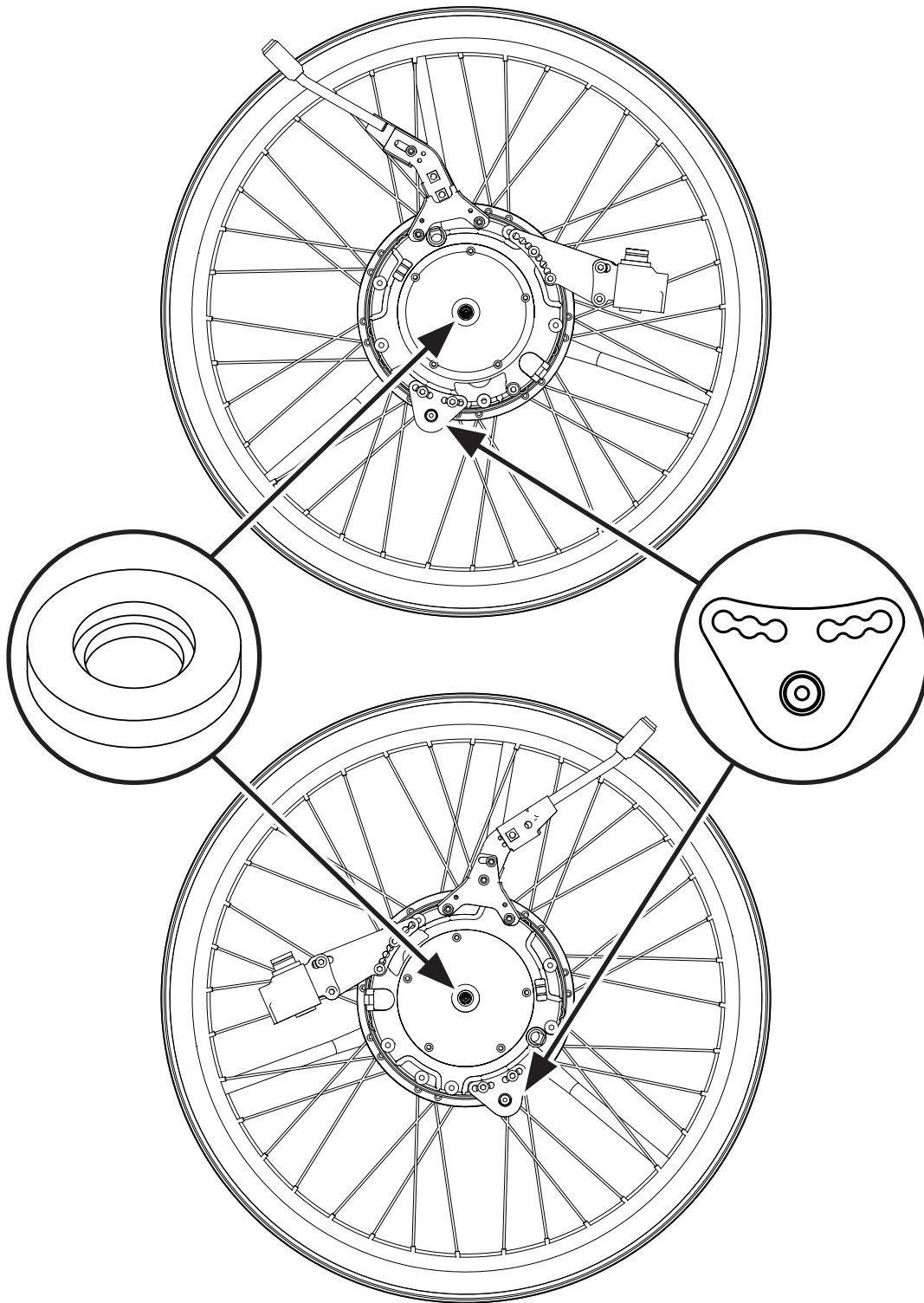









Vassilli - Hi-Lo 18.64P
MEM6545P / MEM6546P

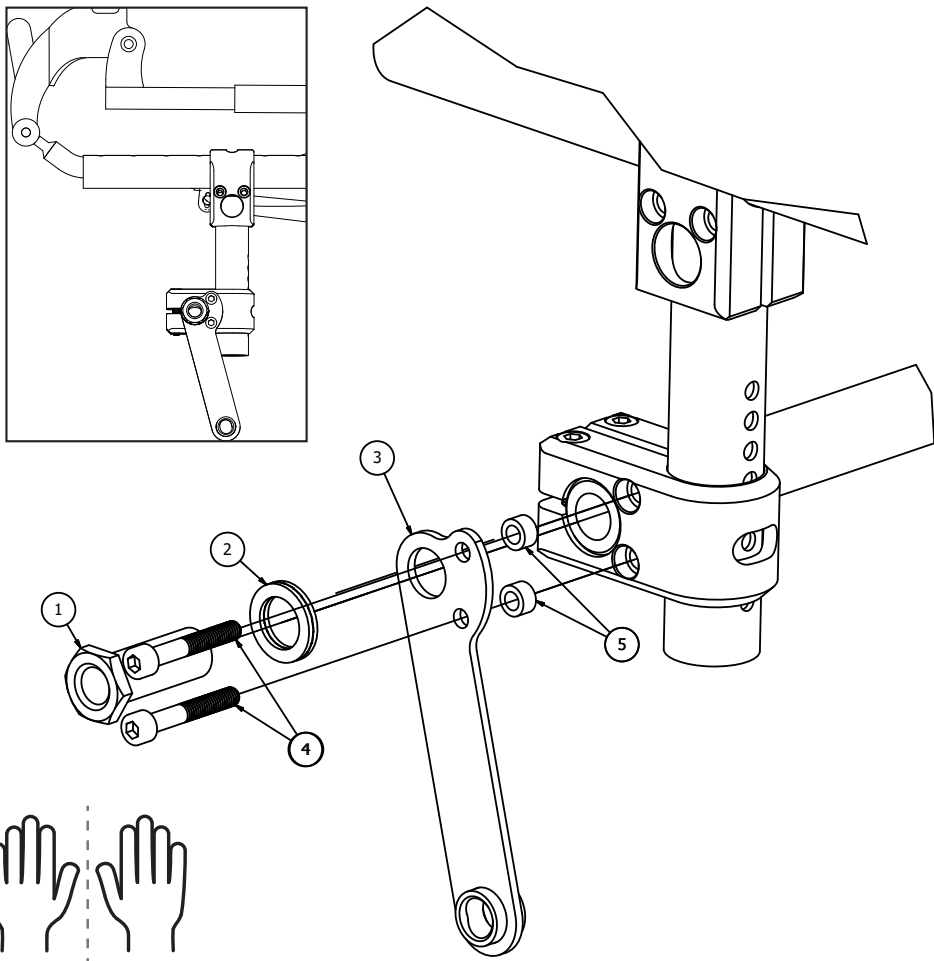

1	XOE-2530E-B0	1	 $\varnothing 12,0 \times 51$
2	XOE-25383-00	1	
3	93440-120520	1	
4	320003	1	



1	HW063	1	
2	405239	1	
3	340078	1	
4	MC6SM6X40	2	
5	100 400 131	2	



NiMH

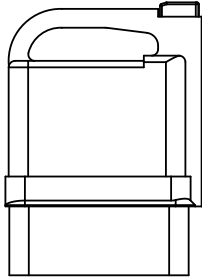

Li-ion

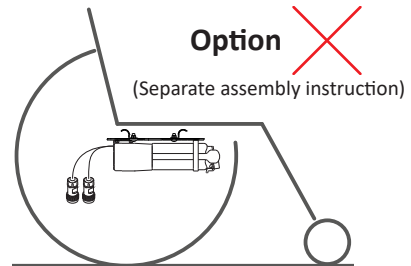
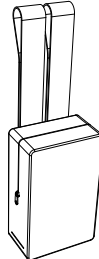
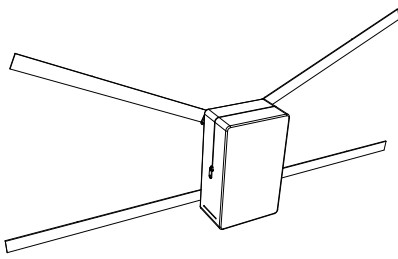
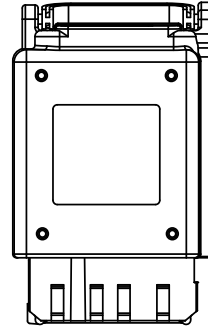

NiMH



Li-ion



NiMH



Li-ion



NiMH



Li-ion

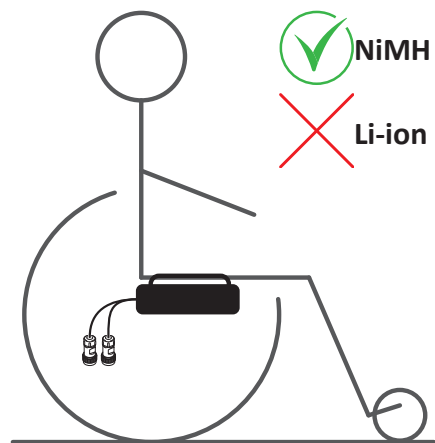
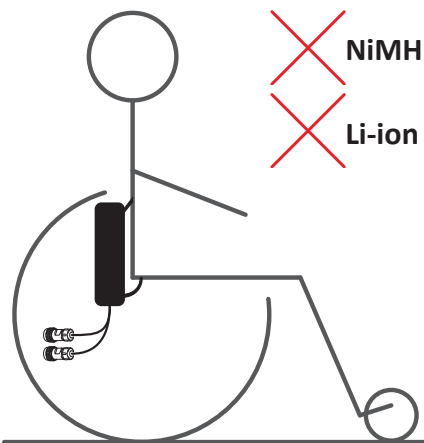

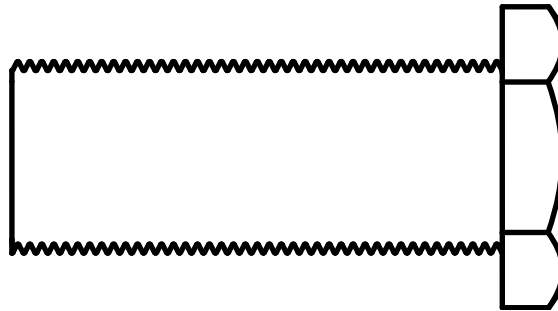

M16x1	30 Nm
M18x1	40 Nm

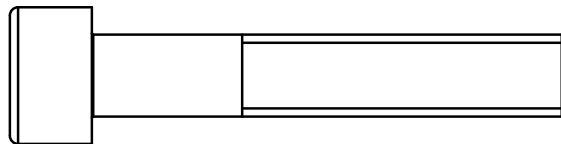

M3	1.2 Nm
M4	3 Nm
M5	6 Nm
M6	10 Nm
M8	25 Nm
M10	50 Nm
M12	85 Nm